







# AC/DC Solar Air Conditioner

## PRODUCT BENEFITS

-  Helps reduce 40-80% of electricity bill.
-  SEER up to 36 with solar, SEER23 without solar.
-  Enjoy cooling effect for free during sunny days.
-  Small investment with big return.
-  Level up the quality of life.
-  Reduce the carbon footprint.



## COMBINATION

- 9000BTU with 3 x 550W Solar Panels
- 12000BTU with 3 x 550W Solar Panels
- 18000BTU with 4 x 550W Solar Panels
- 24000BTU with 5 x 550W Solar Panels



**SCHEMATIC DIAGRAM**

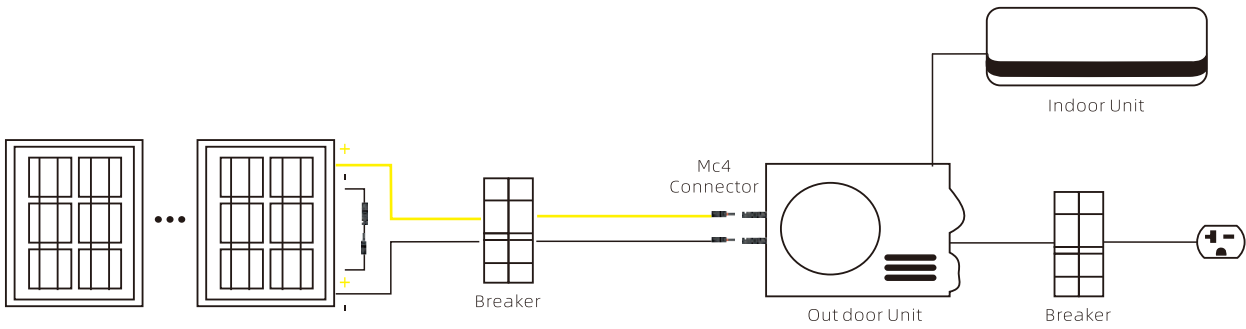

**APPLICATION SCENARIO**



**USAGE SCENARIOS**

Type 1: Solar Power + Grid Power (DC + AC)

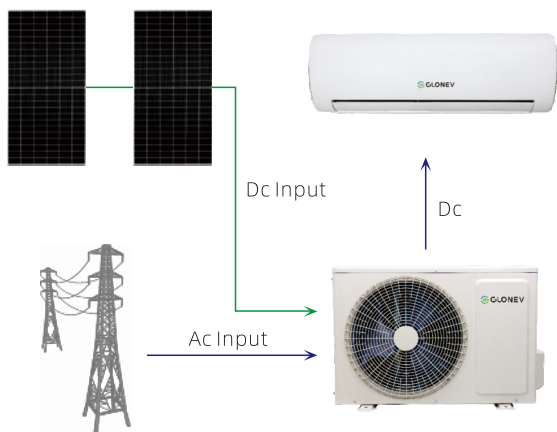

Type 2: Solar Power + Grid Power + Battery (DC + AC + BT)

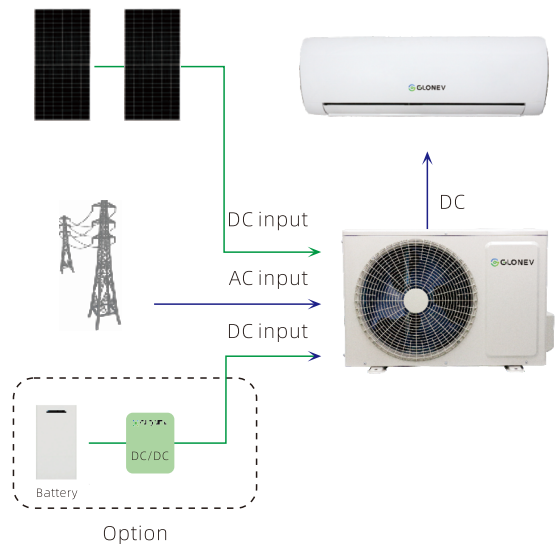

**INTRODUCTION OF SOLAR AIR CONDITIONER**

GLONEV hybrid solar air conditioner features both the **on-grid** and **off-grid** modes, cooling and heating type. It can be powered by solar power only, or solar power & AC power together. This solar air conditioner can be used with **100% solar power**, and help cut **40-80%** of daytime electricity cost (by on-grid). Compared with normal mini split, the built-in system of our product is very high efficient (produces an equivalent **SEER up to SEER 35**) even if you are using it with the AC power only. Normally speaking, using the AC unit is the biggest power consumption for any scenarios, which account for 60% of the electricity bill. GLONEV solar mini split adopts the technology of **solar direct-drive** (runs directly with the solar power) generated from the solar panels, **no battery or inverter required**. Therefore, it can save your electricity bill during daytime.

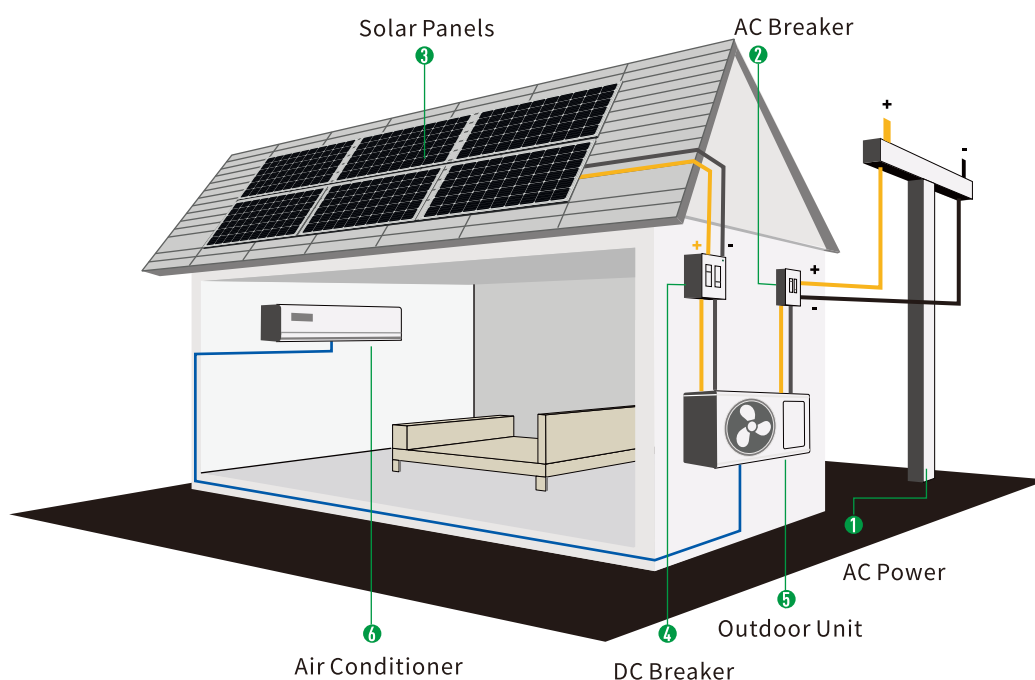
**HIGHLIGHTS**
**01** Directly powered by solar panels

Using 100% of solar power during daytime.  
Helps save up to 97% of electricity cost.

**02** Application

Working temperatures: -10 to +52°C. Designed to meet the T3 environment. Wide working voltages : AC160V-250V. Designed to meet the situation with remote network or unstable voltage.

**03** Easy installing to the solar panels

The installation between solar panels and solar air conditioner is easy. Identify the polarity of the solar cables, then connect them to the input port of the outdoor unit.

**04** Features super energy-saving and extra cooling effect

The compressor with large capacity and the heat exchanging system provide excellent cooling performance. When using it with the solar energy, it can offer SEER up to SEER 35, and SEER 25 without solar power.

**ENERGY SAVING TECHNOLOGY ENERGY**

**Efficient utilization of solar energy, MPPT tracking efficiency > 99.9%**

The MPPT independently developed algorithm ensures that the air conditioner can operate smoothly even when the solar panel input is unstable, with full DC direct drive power supply and a photovoltaic energy utilization rate of up to 99.9%.

65V-380V MPPT

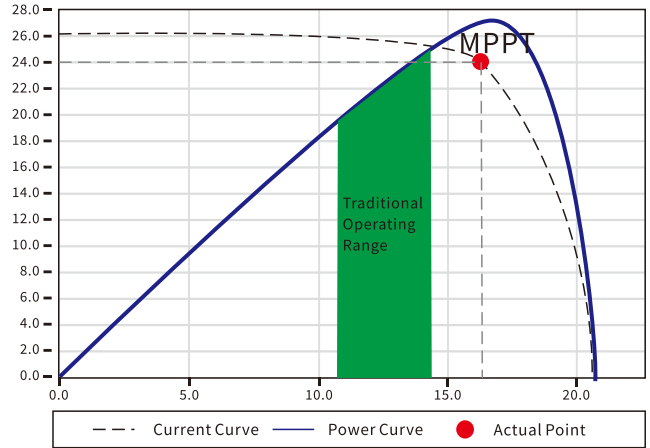

**ECONOMIC BENEFITS**

**1 Glonev Solar Air Conditioner**

Saves at least 1200kWh of utility power per year

Equivalent to planting 2 trees per year

Green light energy can be realized without additional investment of large several dry inverters. When there is sufficient light, full photovoltaic power supply can be realized during the daytime, with high efficiency of photovoltaic conversion, full DC direct drive power supply, and photovoltaic power utilization rate of up to 99.9%

	China	U.S.A	German
Rated Capacity	860W	←	←
Maximum capacity	1500W	←	←
Daytime power	6.9kWh	←	←
Annual operating days	180days	←	←
Annual electricity saving	1238 Kwh	←	←
Unit price of utility electricity	¥0.69/KWh	¥1.20/KWh	¥2.87/KWh
Annual electricity saving	¥854	¥1480	¥3548
Number of PV panels installed	2 pcs	←	←
Maximum output power of PV panels	550W/pcs	←	←
Area occupied by PV panels	5.5m	←	←
PV module cost (including installation fee)	¥2882	←	←
Payback time	40Month	23Month	10Month

**SEER SAVING**

A SEER 23 rating without solar and SEER 35 with solar

Even when the sun is not shining at all (eg. at night), our ultrahigh efficient solar air conditioner will keep you comfortable and save you money using far less electricity than a normal A/C of the same capacity.

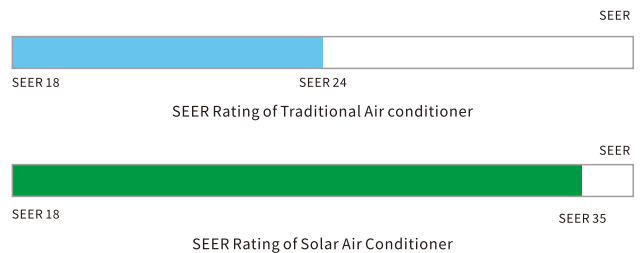

## SPECIFICATIONS

Power supply source			GL-ADC09GW-XA- R32	GL-ADC12GW-XA- R32	GL-ADC18GW-XA- R32	GL-ADC09GW-24- R32	
Power supply source	V/PH/Hz		220-240V 50Hz/60Hz	220-240V 50Hz/60Hz	220-240V 50Hz/60Hz	220-240V 50Hz/60Hz	
	DC		DC90-380V MAX.15A	DC90-380V MAX.15A	DC90-380V MAX.15A	DC90-380V MAX.20A	
Rated Capacity	Cooling	W	2500	3500	5000	7000	
	Heating	W	2600	3600	5100	7200	
Rated Power consumption	Cooling	W	735	1030	1520	2100	
	Heating	W	670	980	1550	2180	
Rated Running Current	Cooling	A	3.2	4.7	6.9	9.2	
	Heating	A	2.9	4.5	7	9.5	
Max. Input Power	W		1450	1870	2860	3800	
Max. Input Current	A		6.6	8.5	13	17..2	
SEER Cooling	W/W		SEER6.6	SEER6.6	SEER6.6	SEER6.6	
SCOP Heating	W/W		SCOP4.6	SCOP4.6	SCOP4.0	SCOP4.0	
Refrigerant	-		R32	R32	R32	R32	
Refrigerant Charged	G		900	900	920	1260	
Air Flow Volume	m <sub>s</sub> /h		650	650	900	1200	
Noise level (INDOOR)	dB(A)		41	42	45	48	
Noise level(OUTDOOR)	dB(A)		50	50	52	56	
Connect pipe	Liquid tube Diameter x Thickness	mm	Φ6*0.5	Φ6*0.5	Φ6*0.5	Φ6*0.5	
	Gas tube	mm	Φ9.52*0.6	Φ9.52*0.6	Φ12.7*0.7	Φ15.88*0.9	
Compressor parameter	Compressor Model		KSN108D34UFZ	KSN108D34UFZ	FTz-SM151AXBA	FTz-SM151AXBA	
	Drive mode	AC/DC	DC	DC	DC	DC	
	type		Rolling Rotor Type	Rolling Rotor Type	Rolling Rotor Type	Rolling Rotor Type	
	Brand		GMCC	GMCC	LANDA	GMCC	
	Capacity	W	3405±5%	3405±5%	5780±5%	7740±5%	
	Input	W	860±5%	860±5%	1320±5%	2065±5%	
Rated Current(RLA)	A	5.8±5%	5.8±5%	6.0±5%	9.4±5%		
Dimension	Outdoor	Net Dimension(WxDxH)	mm	795x290x555	795x290x555	795x290x555	860x304x733
		Packing	mm	910*400*630	910*400*630	910*400*630	1005*450*820
	Indoor	Net Dimension(WxDxH)	mm	895*203*300	895*203*300	1000*240*310	1130*245*320
		Packing Dimension(WxDxH)	mm	965*375*370	965*375*370	1075*310*385	1195*310*390
Indoor unit weight (Gross/Net)	Kg		11/9	11/9	14.5/12.5	17.5/15.5	
Outdoor unit weight (Gross/Net)	Kg		38.5/34.5	38.5/34.5	39/35	55/51	
Loading qty (20/40Q/40HQ)			90/176/194	90/176/194	79/160/180	50/105/120	



DC EEV



DC Air Compressor



DC Stepper Motor



DC Outdoor Motor

**PRODUCT PHOTOS**

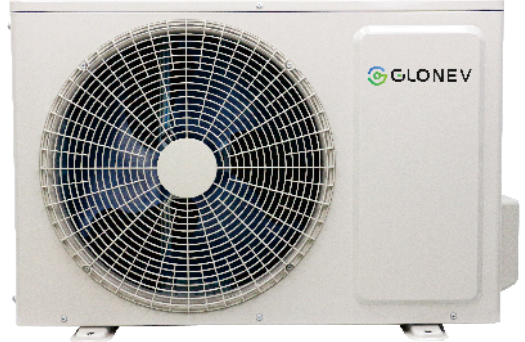

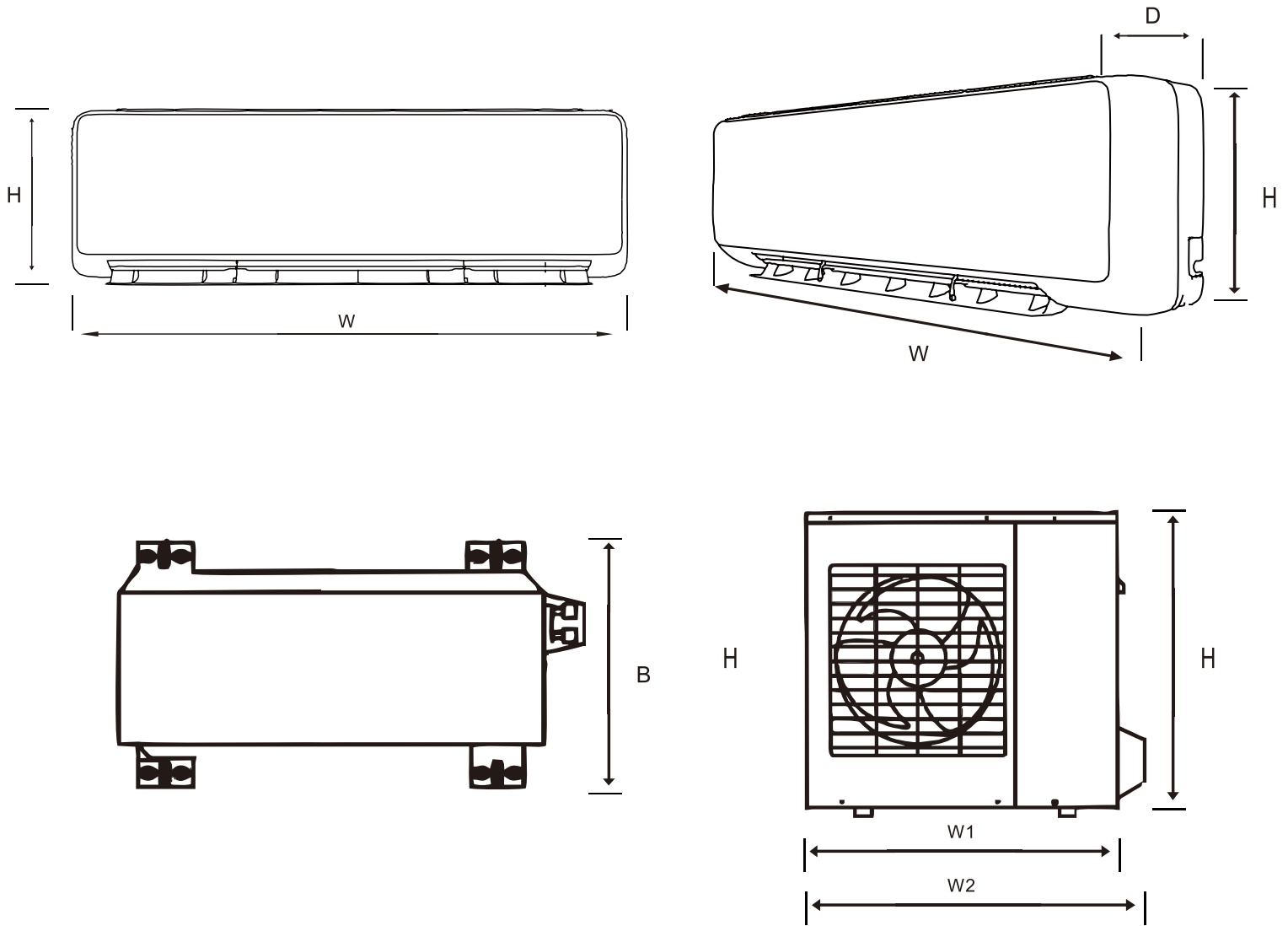

**DIMENSION**

MODEL	Indoor					
	Product Size			Packing Size		
	W	D	H	W	D	H
GL-ADC09GW-XA- R32	895	203	300	965	375	370
GL-ADC12GW-XA- R32	895	203	300	965	375	370
GL-ADC18GW-XA- R32	1000	240	310	1075	310	385
GL-ADC09GW-24- R32	1130	245	320	1195	310	390

MODEL	Outdoor						
	Product Size				Packing Size		
	W1	W2	H	B	W	D	H
GL-ADC09GW-XA- R32	760	810	555	280	910	400	630
GL-ADC12GW-XA- R32	760	810	555	280	910	400	630
GL-ADC18GW-XA- R32	760	810	555	280	910	400	630
GL-ADC09GW-24- R32	800	860	733	315	1005	450	820

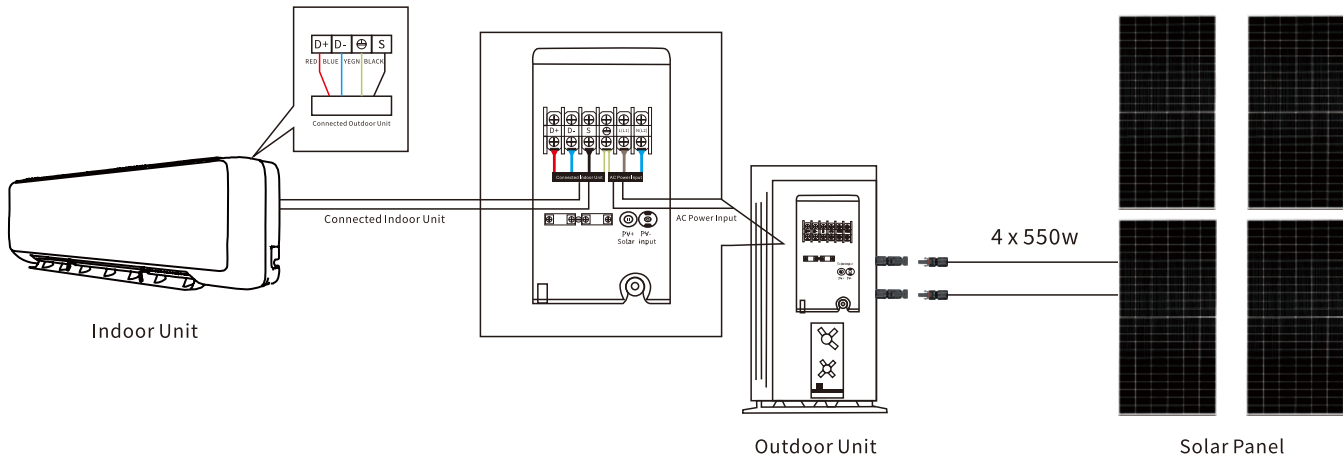
### OUTDOOR WIRING DIAGRAM



### OPTIONAL PARTS

Lightning Arrester



PC40-85VDC

Fuse-Protection



RT28N-32X 1P

Dc Breaker



DC800V 2P 20A

Dc Cable



Cross Section: 4m'.6m'  
Optional Rated Voltage: 600VDC(UL)/1000VDC(TUV)  
Rated Current: 55A.70A

### APP CONTROL

